

S.C. Brake Motor 90W (□90mm)

90W

Speed Control
Brake Motor
90W(□90mm)

Motor Specification

Model 9SBDG*-90F2□: Gear Type Shaft 9SBD□*-90F2: D-Cut Type Shaft 9SBDK*-90F2: Key Type Shaft	Output W	Voltage V	Frequency Hz	Poles	Duty	Speed Range r/min	Starting Torque		Permissible Torque				Capacitor μF / VAC
							kgfcm	N.m	1200r/min		90r/min		
									kgfcm	N.m	kgfcm	N.m	
9SBDGA-90F2□	90	1∅110	60	4	30min.	90-1700	6.50	0.650	6.30	0.630	3.00	0.300	25.0 / 250
9SBDGD-90F2□	90	1∅220	60	4	30min.	90-1700	6.50	0.650	6.30	0.630	3.00	0.300	6.0 / 400
9SBDGE-90F2□	90	1∅220	50	4	30min.	90-1400	4.60	0.460	5.40	0.540	2.20	0.220	6.0 / 400
		1∅240					5.50	0.550	6.10	0.610	2.20	0.220	

1) Enter the phase & voltage code in the place * and enter the model type of attaching Gearbox in the box (□) within the motor model name.

2) All models contain a built-in thermal protector.

3) Gear Type Shaft are for attaching Gearbox and D-Cut & Key Type Shaft are for using motor only.

Max. Permissible Torque at Output Shaft of Gearbox

Motor Model	Gearbox Model	r/min	V	Hz	Gear Ratio	2	3	3.6	5	6	7.5	9	12.5	15	18	20
9SBDG□ -90F2P	9PBK□BH	1200	110	60	kgfcm N.m	10.5 1.02	15.7 1.54	18.8 1.84	26.1 2.56	31.4 3.07	39.2 3.84	47.1 4.61	59.1 5.79	70.9 6.95	85.1 8.33	85.7 8.40
			220	60	kgfcm N.m	10.5 1.02	15.7 1.54	18.8 1.84	26.1 2.56	31.4 3.07	39.2 3.84	47.1 4.61	59.1 5.79	70.9 6.95	85.1 8.33	85.7 8.40
			220/ 240	50	kgfcm N.m	10.1 0.99	15.2 1.49	18.2 1.79	25.3 2.48	30.4 2.98	38.0 3.72	45.6 4.47	57.2 5.60	68.6 6.73	82.4 8.07	83.0 8.13
	9PFG□BH	90	110	60	kgfcm N.m	5.0 0.49	7.5 0.73	9.0 0.88	12.5 1.22	14.9 1.46	18.7 1.83	22.4 2.20	28.1 2.76	33.8 3.31	40.5 3.97	40.8 4.00
			220	60	kgfcm N.m	5.0 0.49	7.5 0.73	9.0 0.88	12.5 1.22	14.9 1.46	18.7 1.83	22.4 2.20	28.1 2.76	33.8 3.31	40.5 3.97	40.8 4.00
			220/ 240	50	kgfcm N.m	3.7 0.36	5.5 0.54	6.6 0.64	9.1 0.89	11.0 1.07	13.7 1.34	16.4 1.61	20.6 2.02	24.8 2.43	29.7 2.91	29.9 2.93

Motor Model	Gearbox Model	r/min	V	Hz	Gear Ratio	25	30	36	40	50	60	75	90	100	120	150	180	200
9SBDG□ -90F2P	9PBK□BH	1200	110	60	kgfcm N.m	107.1 10.50	128.5 12.59	154.2 15.11	171.4 16.79	200.0 19.60	200.0 19.60	200.0 19.60	200.0 19.60	200.0 19.60	200.0 19.60	200.0 19.60	200.0 19.60	200.0 19.60
			220	60	kgfcm N.m	107.1 10.50	128.5 12.59	154.2 15.11	171.4 16.79	200.0 19.60	200.0 19.60	200.0 19.60	200.0 19.60	200.0 19.60	200.0 19.60	200.0 19.60	200.0 19.60	200.0 19.60
			220/ 240	50	kgfcm N.m	103.7 10.16	124.4 12.20	149.3 14.63	165.9 16.26	200.0 19.60	200.0 19.60	200.0 19.60	200.0 19.60	200.0 19.60	200.0 19.60	200.0 19.60	200.0 19.60	200.0 19.60
	9PFG□BH	90	110	60	kgfcm N.m	51.0 5.00	61.2 6.00	73.4 7.20	81.6 8.00	102.0 10.00	122.4 12.00	137.3 13.45	164.7 16.14	183.0 17.93	200.0 19.60	200.0 19.60	200.0 19.60	200.0 19.60
			220	60	kgfcm N.m	51.0 5.00	61.2 6.00	73.4 7.20	81.6 8.00	102.0 10.00	122.4 12.00	137.3 13.45	164.7 16.14	183.0 17.93	200.0 19.60	200.0 19.60	200.0 19.60	200.0 19.60
			220/ 240	50	kgfcm N.m	37.4 3.67	44.9 4.40	53.9 5.28	59.8 5.86	74.8 7.33	89.8 8.80	100.7 9.86	120.8 11.84	134.2 13.15	161.0 15.78	200.0 19.60	200.0 19.60	200.0 19.60

B AC Motors

S.C. Brake Motor 90W ($\square 90\text{mm}$)

Max. Permissible Torque at Output Shaft of Gearbox

Motor Model	Gearbox Model	r/min	V	Hz	Gear Ratio	3	3.6	6	9	12.5	15	18	20	25	30	36	50	60	75	90	100	120	150	180		
9SBDG□ -90F2H	9HBK□BH	1200	110	60	kgfcm	15.7	18.8	31.4	47.1	59.1	70.9	85.1	85.7	107.1	128.5	154.2	214.2	257.0	288.2	300.0	300.0	300.0	300.0	300.0	300.0	
					N.m	1.54	1.84	3.07	4.61	5.79	6.95	8.33	8.40	10.50	12.59	15.11	20.99	25.19	28.25	29.40	29.40	29.40	29.40	29.40	29.40	29.40
			220	60	kgfcm	15.7	18.8	31.4	47.1	59.1	70.9	85.1	85.7	107.1	128.5	154.2	214.2	257.0	288.2	300.0	300.0	300.0	300.0	300.0	300.0	300.0
			N.m	1.54	1.84	3.07	4.61	5.79	6.95	8.33	8.40	10.50	12.59	15.11	20.99	25.19	28.25	29.40	29.40	29.40	29.40	29.40	29.40	29.40	29.40	
	220/240	50	kgfcm	15.2	18.2	30.4	45.6	57.2	68.6	82.4	83.0	103.7	124.4	149.3	207.4	248.9	279.1	300.0	300.0	300.0	300.0	300.0	300.0	300.0	300.0	300.0
			N.m	1.49	1.79	2.98	4.47	5.60	6.73	8.07	8.13	10.16	12.20	14.63	20.33	24.39	27.35	29.40	29.40	29.40	29.40	29.40	29.40	29.40	29.40	29.40
	9HFK□BH	90	110	60	kgfcm	7.5	9.0	14.9	22.4	28.1	33.8	40.5	40.8	51.0	61.2	73.4	102.0	122.4	137.3	164.7	183.0	219.6	274.5	300.0	300.0	
					N.m	0.73	0.88	1.46	2.20	2.76	3.31	3.97	4.00	5.00	6.00	7.20	10.00	12.00	13.45	16.14	17.93	21.52	26.90	29.40	29.40	29.40
			220	60	kgfcm	7.5	9.0	14.9	22.4	28.1	33.8	40.5	40.8	51.0	61.2	73.4	102.0	122.4	137.3	164.7	183.0	219.6	274.5	300.0	300.0	
			N.m	0.73	0.88	1.46	2.20	2.76	3.31	3.97	4.00	5.00	6.00	7.20	10.00	12.00	13.45	16.14	17.93	21.52	26.90	29.40	29.40	29.40	29.40	
	220/240	50	kgfcm	5.5	6.6	11.0	16.4	20.6	24.8	29.7	29.9	37.4	44.9	53.9	74.8	89.8	100.7	120.8	134.2	161.0	201.3	241.6	294.0	294.0	294.0	
			N.m	0.54	0.64	1.07	1.61	2.02	2.43	2.91	2.93	3.67	4.40	5.28	7.33	8.80	9.86	11.84	13.15	15.78	19.73	23.67	26.90	29.40	29.40	

Motor Model	Gearbox Model	r/min	V	Hz	Gear Ratio	10	12	15	18	25	30	36	50	60	
9SBDG□ -90F2W	9WD□BL/ □BR/□BRL	1200	110	60	kgfcm	51.7	60.5	72.8	83.9	110.3	124.7	145.2	142.9	122.4	
					N.m	5.06	5.93	7.13	8.22	10.80	12.22	14.22	14.00	12.00	12.00
			220	60	kgfcm	51.7	60.5	72.8	83.9	110.3	124.7	145.2	142.9	122.4	122.4
				N.m	5.06	5.93	7.13	8.22	10.80	12.22	14.22	14.00	12.00	12.00	
		220/240	50	kgfcm	50.0	58.6	70.5	81.3	106.8	120.8	140.5	142.9	122.4	122.4	
				N.m	4.90	5.74	6.90	7.96	10.46	11.84	13.77	14.00	12.00	12.00	
90	110	60	kgfcm	24.6	28.8	34.7	40.0	52.5	59.4	69.1	90.0	99.0	99.0		
			N.m	2.41	2.82	3.40	3.92	5.15	5.82	6.77	8.82	9.70	9.70		
	220	60	kgfcm	24.6	28.8	34.7	40.0	52.5	59.4	69.1	90.0	99.0	99.0		
		N.m	2.41	2.82	3.40	3.92	5.15	5.82	6.77	8.82	9.70	9.70			
220/240	50	kgfcm	18.0	21.1	25.4	29.3	38.5	43.6	50.7	66.0	72.6	72.6			
		N.m	1.77	2.07	2.49	2.87	3.77	4.27	4.97	6.47	7.11	7.11			

Motor Model	Gearbox Model	r/min	V	Hz	Gear Ratio	7.5	10	15	20	25	30	40	50	60	80
9SBDG□ -90F2WH	9WHDD□-030	1200	110	60	kgfcm	39.7	51.0	71.8	90.7	104.0	121.0	148.7	170.1	163.3	132.7
					N.m	3.89	5.00	7.04	8.89	10.19	11.85	14.57	16.67	16.00	13.00
			220	60	kgfcm	39.7	51.0	71.8	90.7	104.0	121.0	148.7	170.1	163.3	132.7
				N.m	3.89	5.00	7.04	8.89	10.19	11.85	14.57	16.67	16.00	13.00	
		220/240	50	kgfcm	38.4	49.4	69.5	87.8	100.7	117.1	144.0	164.7	163.3	132.7	
				N.m	3.77	4.84	6.81	8.61	9.86	11.48	14.11	16.14	16.00	13.00	
90	110	60	kgfcm	18.9	24.3	34.2	43.2	49.5	57.6	70.8	81.0	90.0	105.6		
			N.m	1.85	2.38	3.35	4.23	4.85	5.64	6.94	7.94	8.82	10.35		
	220	60	kgfcm	18.9	24.3	34.2	43.2	49.5	57.6	70.8	81.0	90.0	105.6		
		N.m	1.85	2.38	3.35	4.23	4.85	5.64	6.94	7.94	8.82	10.35			
220/240	50	kgfcm	13.9	17.8	25.1	31.7	36.3	42.2	51.9	59.4	66.0	77.4			
		N.m	1.36	1.75	2.46	3.10	3.56	4.14	5.09	5.82	6.47	7.59			

- 1) Enter the phase & voltage code in the box (\square) within the motor model name.
- 2) Enter the gear ratio in the box (\square) within the Gearbox model name.
- 3) A colored background indicates gear shaft rotation in the same direction as the motor shaft; a white background indicates rotation in the opposite direction.
- 4) The rotating speed is calculated by dividing the motor's synchronous speed (50Hz: 1,500r/min, 60Hz: 1,800r/min) by the gear ratio.
The actual speed is 2~20% less than the displayed value, depending on the size of the load.

Dimensions

MOTOR ONLY

- MOTOR MODEL:
9SBD□-90F2 (POWERFUL FAN)

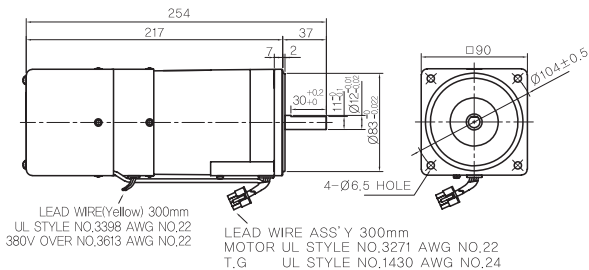

INTER-DECIMAL GEARBOX

- MODEL: 9XD10□□

MOTOR OUTPUT SHAFT

MODEL	SPEC
D-CUT TYPE	37 30 ^{+0.1} 25 ^{+0.05} 12 ^{+0.01}
KEY TYPE	37 25 ^{+0.05} 12 ^{+0.01}

KEY SPEC

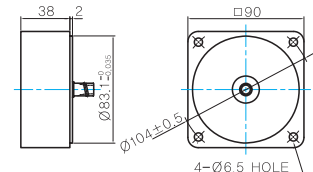
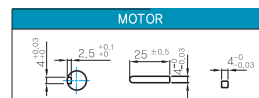

GEARED MOTOR

● P TYPE GEARBOX

● MOTOR MODEL:
9SBDG□-90F2P (POWERFUL FAN)

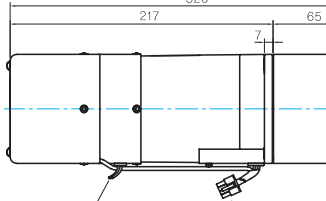

LEAD WIRE(Yellow) 300mm
UL STYLE NO.3398 AWG NO.22
380V OVER NO.3613 AWG NO.22

LEAD WIRE ASS' Y 300mm
MOTOR UL STYLE NO.3271 AWG NO.22
T.G UL STYLE NO.1430 AWG NO.24

● GEARBOX MODEL:
9PBK□BH

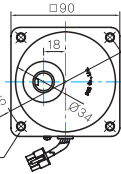

● GEARBOX MODEL:
9PFK□BH

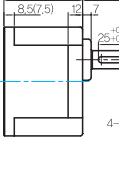

● GEARBOX OUTPUT SHAFT

MODEL	SPEC
9PBK□BH 9PFK□BH	

● KEY SPEC

GEARBOX

● H TYPE GEARBOX

● MOTOR MODEL:
9SBDG□-90F2H (POWERFUL FAN)

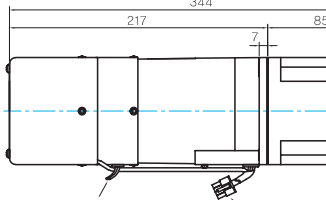

LEAD WIRE(Yellow) 300mm
UL STYLE NO.3398 AWG NO.22
380V OVER NO.3613 AWG NO.22

LEAD WIRE ASS' Y 300mm
MOTOR UL STYLE NO.3271 AWG NO.22
T.G UL STYLE NO.1430 AWG NO.24

● GEARBOX MODEL:
9HBK□BH

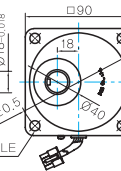

● GEARBOX MODEL:
9HFK□BH

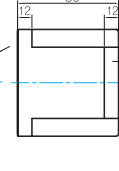

● GEARBOX OUTPUT SHAFT

MODEL	SPEC
9HBK□BH 9HFK□BH	

● KEY SPEC

GEARBOX

● W TYPE GEARBOX

● MOTOR MODEL:
9SBDG□-90F2W (POWERFUL FAN)

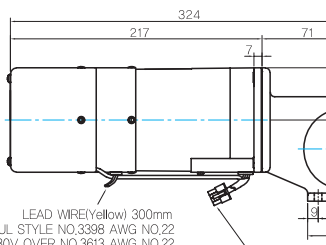

LEAD WIRE(Yellow) 300mm
UL STYLE NO.3398 AWG NO.22
380V OVER NO.3613 AWG NO.22

LEAD WIRE ASS' Y 300mm
MOTOR UL STYLE NO.3271 AWG NO.22
T.G UL STYLE NO.1430 AWG NO.24

● GEARBOX MODEL:
9WDBL/BR/BRL

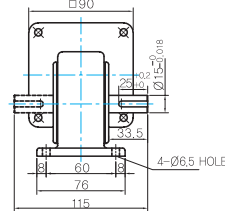

● KEY SPEC

GEARBOX

● WH TYPE GEARBOX

● MOTOR MODEL:
9SBDG□-90F2WH (POWERFUL FAN)

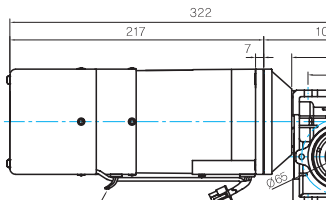

LEAD WIRE(Yellow) 300mm
UL STYLE NO.3398 AWG NO.22
380V OVER NO.3613 AWG NO.22

LEAD WIRE ASS' Y 300mm
MOTOR UL STYLE NO.3271 AWG NO.22
T.G UL STYLE NO.1430 AWG NO.24

● GEARBOX MODEL:
9WHD□-030

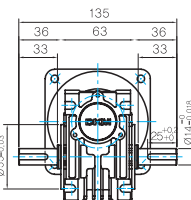

● SHAFT(Unidirectional, Bi-directional)

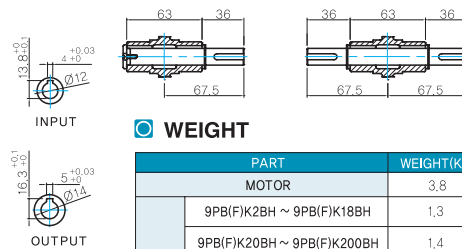

● WEIGHT

PART	WEIGHT(Kg)	
MOTOR	3.8	
GEAR BOX	9PB(F)K2BH ~ 9PB(F)K18BH	1.3
	9PB(F)K20BH ~ 9PB(F)K200BH	1.4
	9HB(F)K3BH ~ 9HB(F)K9BH	1.45
	9HB(F)K12.5BH ~ 9HB(F)K18BH	1.5
	9HB(F)K20BH ~ 9HB(F)K60BH	1.7
9HB(F)K75BH ~ 9HB(F)K200BH	1.8	
9WDBL/BR/BRL	1.0	
9WHD□-030	1.13	
9XD10□	0.5	

● FLANGE

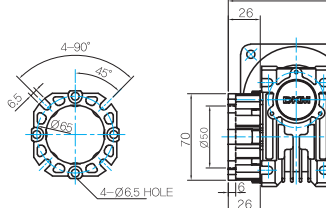

● KEY SPEC

GEARBOX

* The output flange and shafts are sold separately.

B AC Motors

S.C. Brake Motor 90W (□90mm)

Motor Images

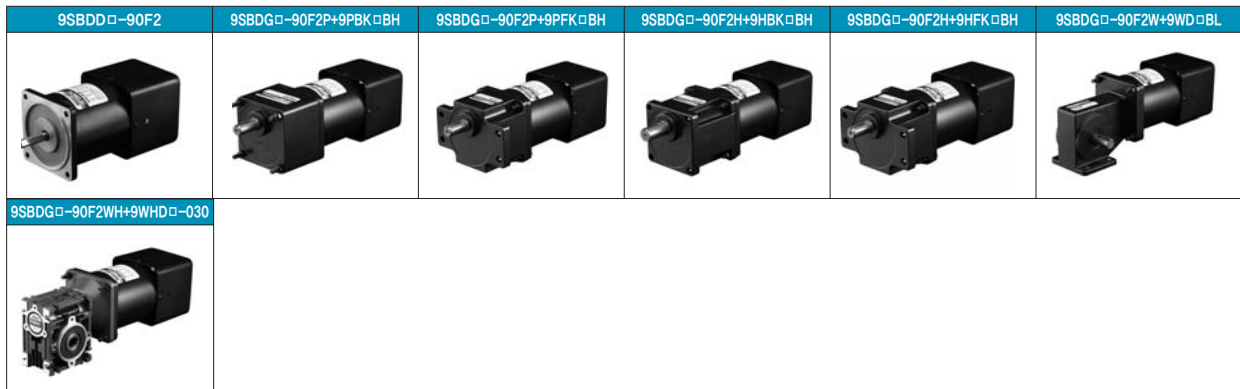

Connection Diagrams

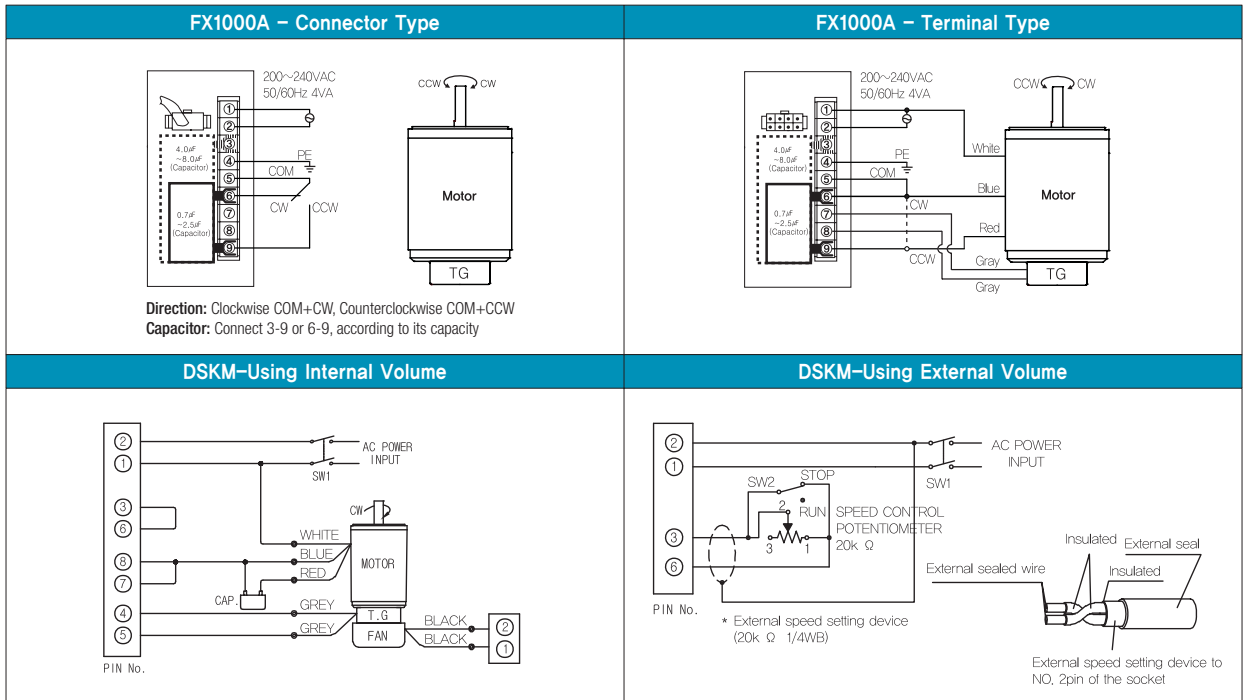

- 1) At first connect the speed controller with the motor as instructed in connection diagrams. And then input the external power to both of the terminal 'AC' for the rated speed operation.
Now you can adjust the main volume to control the output speed of motor.
- 2) The direction of motor rotation is as viewed from the shaft end of the motor.
- 3) CW represents the clockwise direction, while CCW represents the counterclockwise direction.
- 4) When using powerful fan (F2 type) attached motor, connect two black wires of the fan to No.1 and No.2 terminals in order to supply power.